

ecoSep oil water separator

operating and maintenance instruction

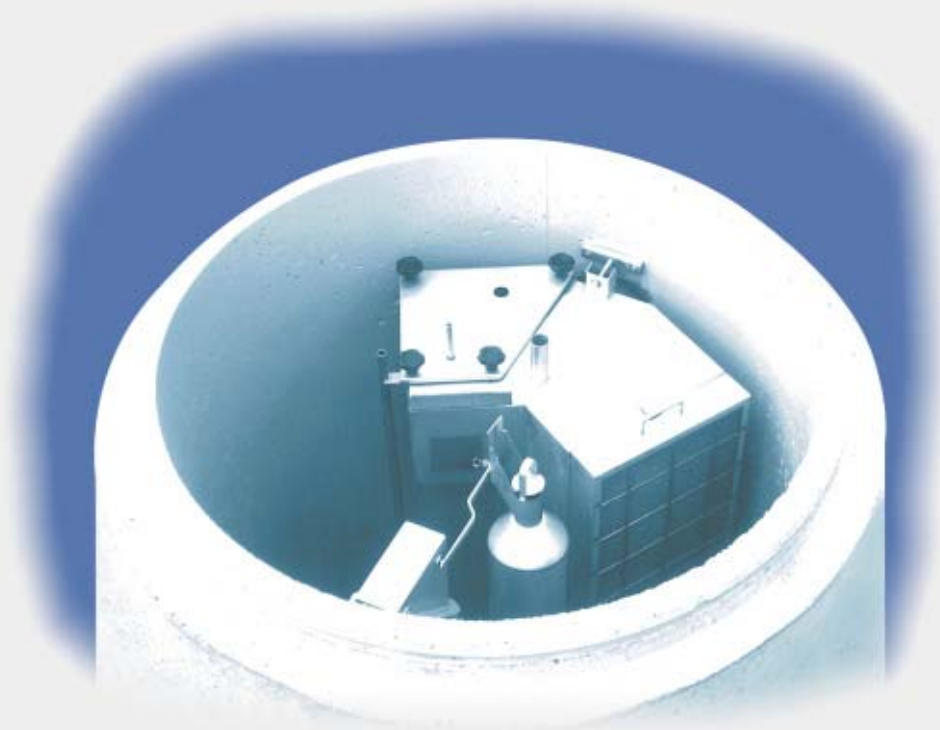

ecoSep

ecoSep oil water separator

operating and maintenance instruction

EcoSep Quality Certificate

Our components are fabricated by well-educated specialists out of high-grade stainless steel (grade 304) Chemical resistance of our materials meets the common guidelines of oil/water separators.

For special cases (chloride containing wastewater) the materials have to be adapted to the field of application.

For every single ecoSep oil water separator we perform the following tests:

Automatic Closure Device

- The weight of the float in water exceeds two times the force required to shut the valve.
- The closed valve is watertight to 50kPa pressure (5m total head).
- The float is tested for tightness and proper calibration according to its labeling.

Outlet structure

- Oil recipient and all corresponding gaskets are inspected for tightness.
- Accuracy of welding seams and quality of anodization of stainless steel.
- Mechanism of quick lock for filter cartridge.

Automatic oil-drawoff device

- All parts are free moving.
- Tightness of inlet and outlet valve.
- Tightness of casing.

With ecoSep you receive a high-grade quality product, that (by proper use) exceeds all guidelines of European, Australian and North American Standards for oil/water separation.

ecoTECHNIC GmbH & Co KG, Austria

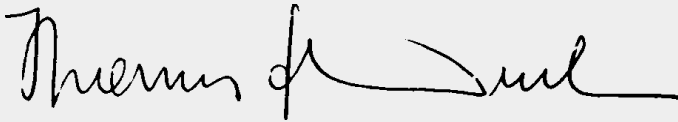

Dipl.-Ing. Thomas Fleischanderl
Managing Director

ecoSep oil water separator

operating and maintenance instruction

Installation



Location

The separator must be installed below grade, as close as possible to the source of run-off. When choosing the location, make sure that the separator as well as the grit chamber can easily be accessed for installation as well as for maintenance vehicles. As much as possible avoid any pipes or hydraulic structures that might cause turbulence upstream to the separator. To ensure unimpeded flow to and from the system, inlet and outlet pipes of the separation system should have a grade of at least 2%. Ensure that there is a firm standing area available on site to receive the units and they are securely stacked so there is no danger of units falling or rolling.

Preparing the installation pit



When the separator location has been determined the area should be excavated to a width to provide side clearance and correct depth for the base slab. Width of floor = outside diameter of the concrete manhole + 1 m. The pit must be deeper than the stated installation depth, so as to allow for the depth of a sand bed or of any concrete base that might be necessary. Benching and/or shoring may be required depending on soil conditions and depth of installation.

Preparing the floor

The separator can be placed straight onto a sand bed (min. thickness 75mm) compacted to the design level. Where the bearing capacity of the soil is insufficient, a base platform must first be constructed, a sand bed at least 75mm thick is then placed on top of this.



Installing the separator

The separator is lowered into the pit by using a lifting beam to prevent any damage of the precast tanks. Ensure that once lifted into place the separator is level and that the inlet and outlet invert levels are at the correct level and alignment. If the system is installed at a location with high groundwater level, check buoyancy of the empty tanks (safety factor > 1.1).

Make sure that all connections between submerged concrete elements (tank-cover-slab-riser rings-base) are well sealed. All joints below the inlet and outlet pipe levels must be sealed using an epoxy as described on the drawings. Joints above this can be sealed with a mastic sealant.



IMPORTANT: When placing the cover slab, make sure that the openings in the cover are in the correct orientation. Refer to site drawings.

Pipe connections

Pipe connections are indicated on the site drawings. Do not use other connections than specified.

Tightness test

Fill the separator with water to outlet pipe invert level. Mark the water level and leave for 24 hours. Recheck the water level for any leakage over the 24-hour period. If there has been leakage the tank will need to be emptied dry and resealed from the interior before repeating the tightness test.

Backfilling

Loose soil must be placed around the plant, compacted a layer at a time. Backfilling of the system should be completed to the same specification as required for the pipeline.

ecoSep oil water separator

operating and maintenance instruction

Putting into service



To ensure an unimpeded functioning of manual or automatic oil draw-off device, the outlet structure of the system has to be level.

ecoSep oil water separator is equipped with a spirit level, which is located underneath the cover of the oil recipient. To level out the outlet structure, adjust the three bolts that hold the unit to the concrete tank. Before the plant is put into service, the system **MUST** be filled with clean water (unless it has been filled during a tightness test). Any materials left behind from installation (e.g. mortar, soil,...) must be removed prior to filling the tanks with fresh water.



IMPORTANT: Fill the separator via the grit chamber until the separation chamber is full and water leaves the separator through the outlet structure. Make sure that the float is disconnected from the float lever and the inlet valve to the separation chamber is open! The valve is open, when the float lever is in a horizontal position (see section Maintenance of spill control valve and float).

After the system has been filled with water, carefully connect the float to the float lever. Make sure that the float is not getting submerged and the valve remains open! To avoid loss of the float and float-pin, we recommend to secure float pin with a thin wire and float with a light-weight rope.

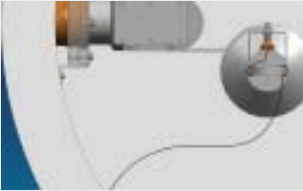

The separator is now ready to work.

ecoSep oil water separator

operating and maintenance instruction

Technical description

General

The ecoSep oil water separator is designed to separate free non-water-soluble light with a maximum specific gravity of 0.95 from water (petroleum byproducts such as gasoline, diesel and other mineral oils).

ecoSep oil water separator does not separate:

- Mechanically or chemically emulsified oils
- Vegetable oil or animal fat
- Solid Grease.

The following kind of influent must NOT be treated with the separator:

- Flow rates exceeding the design flow rate of the system
- Substances which could impede proper functioning (large quantities of suspended particles etc.)
- Detergents and cleaning agents that form stable emulsions
- Wastewater inflows that are still influenced by pump, agitator or vibrator movements
- Wastewater inflows not having pH-values of between 6.0 and 8.0
- Wastewater containing chlorides

Grit Trap

The upstream grit chamber removes solids from the influent, thus ensuring unimpeded functioning of the oil separator itself. The grit trap is the first concrete tank of a standard two-tank design.

The inlet apron guarantees an optimum usage of the retention time in the system. It works against the formation of so called "Eddy-currents", and thus enables maximum solids separation. The grit chamber also compensates for influent temperature fluctuations, influent oil concentration influxes and initializes the separation of light fluids. A perforated 90-degree outlet tube retains floating solids from entering the separation chamber.

Gravity Separation

The water is then admitted to the gravity separator via a float-actuated shut-off valve in the inlet.

Being lighter than water, the oil floats on the surface. ecoSep oil water separator can separate light liquids that have a specific gravity below 0.95.

Oil Spill Control:

The automatic shut-off valve stops the flow from the grit chamber either when the maximum oil storage capacity is reached or when a certain liquid level in the separation chamber is exceeded. In its closed position, the valve is tight up to 50kPa (5m total head) pressure. This makes the ecoSep oil water separator the only separation system to provide maximum security for the facility owner against unexpected, unpredictable and catastrophic petroleum spills.

Coalescing Media

In the coalescing media, fine droplets that are too small to be separated by gravity alone are accumulated into bigger drops that rise to the surface. This coalescing media is made of reticular (i.e. "net-like") soft polyurethane foam. The media-cartridge is very easy to lift out and reinstall once it is cleaned/rinsed with a garden hose. The outlet structure features a venting pipe that provides an effluent sampling port. The separated water that leaves the ecoSep oil water separator has a residual contamination of free petroleum content of less than 5 mg/liter (5ppm).

Manual or Automatic Oil Draw-off Device (ADD)

Separators without an oil draw-off accumulate light fluids in direct contact to the water surface. Increasing emulsification at the oil/water interface is the result. Those stable emulsions, which can no longer be separated by a physical method, would leave the separator. ecoSep oil water separator solves that problem. A standard version of ecoSep oil water separator is equipped with a manual oil draw-off, a valve that can be opened and closed from grade to collect oil in the

ecoSep oil water separator

operating and maintenance instruction

independent oil-recipient. As an option, the patented automatic oil draw-off device (ADD) can be installed. This ADD constantly removes accumulated light fluids from the water surface and stores them in the oil recipient. The collected oil, which is free of any water, can be pumped through a standpipe and disposed of. The costly disposal of large quantities of oil and water mixtures is then eliminated.

ecoSep oil water separator

operating and maintenance instruction

Operation and Maintenance

General

For an unimpeded functioning of the system, the separator has to be maintained periodically. All parts of the separator have to be inspected monthly, as well as after all non-routine events. Please report all damages to the system to the manufacturer. All separated substances (grit, petroleum byproducts, and floatables) have to be pumped and disposed in time.

To make sure that the separator is maintained properly, a person must be designated to this task. Please use the enclosed maintenance sheet to report maintenance work and other events related to the operation of the system.

Due to the danger of explosions, it is strictly forbidden to smoke or light any flames anywhere near the plant, particularly after the cover has been opened.

Before entering the plant, remove the separated oil and make sure that the plant has been well ventilated. Entry into ecoSep oil water separator is considered to be confined space entry and as such all workcover safety precautions for confined space entry must be strictly followed.

Each worker entering the plant must be attached to a safety rope held by another worker staying outside the plant. We recommend wearing breathing apparatus when entering the plant (confined space entry).

The access covers must fit correctly, and must be accessible at all times so that they can be lifted easily when necessary. They must not be covered with earth or any other material. The stated test loads of the cover slabs must not be exceeded.

An authorized specialist company must carry out the maintenance and emptying of the plants. The relevant maintenance and operating manual must be made available to this company. The substances collected when the plants are emptied must NOT be disposed of to the sewer, in standing or flowing water, or sewage treatment plants. They MUST be disposed of by being taken to licensed collection and recycling points.

All damage to the plant must be repaired immediately. It is forbidden to make constructional changes to the plant, to interfere with its mode of action or to increase the dimensions of the inlet or designed flow rates.

Removal of grit

Sediments collected in the grit chamber have to be disposed off on a regular basis.

Cleaning of the media cartridge

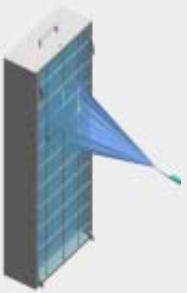

The coalescing media cartridge has to be cleaned periodically. Since the maintenance intervals strongly depend on the very application, check the condition of the element weekly during the first two months of operation. To detach the filter cartridge from the outlet structure, release the quick lock on top of the cartridge and lift the filter on the handle. The filter media can be cleaned/rinsed with a pressure washer or garden hose. Drain the wash-water into the grit chamber of the separator.

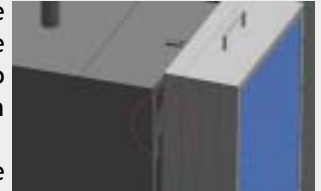

We recommend to insert a replacement cartridge while cleaning the filter element, alternatively shut off any flow through the separation chamber by sinking the float (note MUST ensure this is refloated after cleaning).

IMPORTANT: Do not expose the coalescing media to extended periods of sunlight or UV-radiation!

Removal of accumulated oil

Manual removal of oil

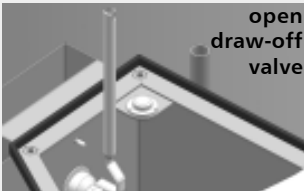

Accumulated oil can just be removed manually when there is no flow through the separator.

Connect the handle to the extension of the manual draw-off valve and turn it 90° counterclockwise to open the valve. Drain oil into the oil recipient and close the valve before water can enter the tank.

During operation of the separator make sure that the manual draw-off is shut.

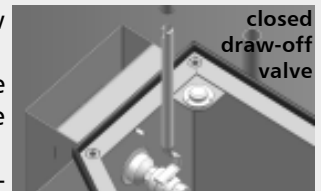

ecoSep oil water separator

operating and maintenance instruction

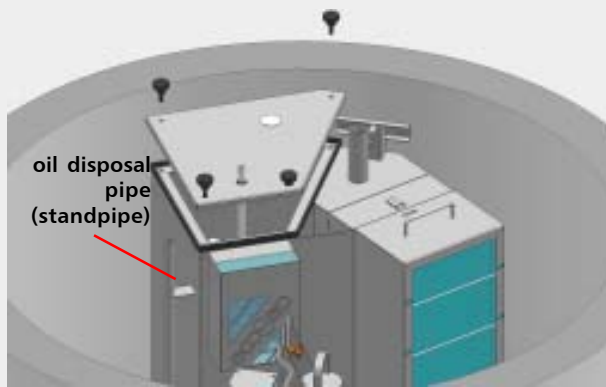

Automatic oil draw-off device

If your ecoSep™ oil water separator is equipped with an automatic oil draw-off device, please see our O&M manual for the ADD.

Oil disposal

To check the liquid level in the oil recipient, remove cover of the recipient. If necessary, pump the collected oil through the standpipe of the oil recipient.

Maintenance of spill control valve and float

The spill control valve at the inlet operates in two working conditions:

- Open valve: Float lever is in a horizontal position, the float is floating in water.
- Closed valve: Float lever is pointing downwards, the float is submerged.

During operation the valve is open, water is admitted to the gravity separator. The automatic shut-off valve stops the flow from the grit chamber either when the maximum oil storage capacity is reached or when a certain liquid level in the separation chamber is exceeded. To set the valve back to its operating condition after a spill, remove the float pin and detach the float from the float lever. Lift out and empty the float. Pump the accumulated oil in the separation chamber and refill the system with fresh water. Use the float pin to connect the float to the float lever again. Make sure to release the float carefully so that it is not sinking. The valve should now be in its operating condition again. If the valve has been closed due to a backup in the separation chamber, please clean the filter element and set the valve back to its operating condition.

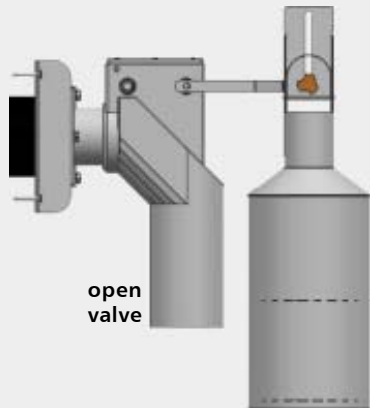

Standard Maintenance

- Detach the float from float lever by removing the float pin (see picture).
- Check whether the float lever is free moving and the valve can be opened and closed easily.
- Check the condition of the gasket.
- To clean the inside of the valve remove lid and rinse with high pressure washer.
- If necessary, lubricate moving parts.

